

Clean Up Your  
**World**<sup>™</sup>



Lawn Care & Maintenance Machinery - Brochure 2021



## Clean up your World™ with Billy Goat!

Thank you for your interest in Billy Goat! For more than 50 years, Billy Goat® has been the leader in making properties across the globe look fantastic. The equipment in this catalogue represents the best in specialty turf products with close attention to detail in an effort to make Billy Goat products simple to operate, highly productive, less fatiguing, and a pleasure to use!

Inside you will find innovative features like advanced fan technology in our blowers; hydrostatic drive systems and intuitive controls in our brushcutters, aerators, overseeders and sod cutters that take the guesswork out of ground speed and direction; customer-friendly ergonomics that reduce noise, weight, dust and vibration across the line.

Rest assured that Billy Goat products are customer focused, engineered and rigorously field tested to our customer's highest requirements which is why they are known for their outstanding durability and rugged performance year after year.

When it comes to cleaning up, Billy Goat features leading solutions for all your residential, commercial, and municipal cleanup needs. We invite you to review our catalog, refer to our website, watch our videos and work with our worldwide network of stocking and servicing dealers to pick the machine that is right for your cleanup needs.

Yours sincerely,  
Billy Goat Industries.







**Ground Care**



Introduction	<b>04</b>
Power Rakes	<b>06</b>
Overseeders	<b>08</b>
Aerators	<b>12</b>
Sod Cutters	<b>22</b>

**Cutting & Mowing**



Introduction	<b>24</b>
Brushcutters	<b>26</b>
Ride-On Brushcutters	<b>30</b>

**Debris Management**



Introduction	<b>32</b>
Force Blowers	<b>34</b>
Stand-On Force Blowers	<b>40</b>
Leaf & Litter Vacuums	<b>42</b>
Debris Loaders	<b>50</b>





# Turf and renovation projects for the perfect property

Keep your lawn in perfect condition with Billy Goat turf and renovation machines. With our powerful power-rakes you can remove thatch from turf the fast way. After that you can make a perfect finish with the over-seeders. Our aerators let air in by the roots. Get to know our sod-cutters for the easiest way to remove turf for your renovation projects or installation of pipework for irrigation in your lawn.

All the machines are made for durable and efficient working. They are very easy to operate making the whole range ideal for residential, professional users and hire companies.











Compact and lightweight

Model shown:  
CR550HCEU

### CR Series

CR550HCEU, CR550H

Billy Goat's Compact Power Rake manoeuvres easily around small properties, removing matted thatch from turf in 51 cm / 20" passes. Its rugged design withstands the most demanding use.

The CR Series comes standard with Honda GC or a commercial GX engine, coupled to a free-swinging heat treated tempered flail blade reel, mounted to construction grade cast iron bearings with grease fittings. The flail reel can be changed over to an optional slicing reel in 10 minutes.

The heavy-duty constructed single-piece units have low vibration due to its reduced overall number of parts, improving operator comfort and handling.

An adjustable idler permits the operator to set the precise tension for maximum belt life. The padded, ergonomic handles are stiff under operation and fold for easy transport and storage.



Heavy duty and convertible to an Overseeder

Model shown:  
PR551V

### PR Series

PR551V, PR550H

The PR Series efficiently removes matted thatch from turf in 251 cm / 20" passes, and its rugged design withstands the most demanding use. The rotation of the flail blade shaft is clock wise, this propels the PR forward, making it self propelled.

As the PR Series weighs slightly more than other power rakes on the market, with steel guards, heavier wheels, premium bearings, and a 3,6 mm steel engine base, the PR absorbs much of the vibration before it is transferred to the handle, which improves operator comfort and handling.

The PR series is powered with a Honda or Vanguard™ engine coupled to a free swinging, heat treated, tempered flail blade reel, mounted to heavy-duty cast iron pillow block bearings with grease fittings.

The PR is convertible to an overseeder or vertislicer with optional accessories.





## Features

### CR Series



**Working Height Adjustment**  
Easy adjust the working height:  
+ 12,7 mm to - 19 mm.

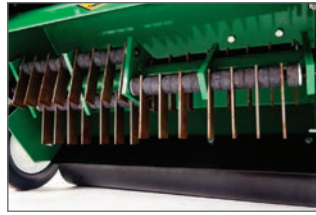

**CR Flail Reel**  
Helps restore healthy growth of turf.  
Can be ordered separately. (350241-S)



**Cast Iron Bearings**  
Complete with grease fittings for  
purging grease.

### PR Series

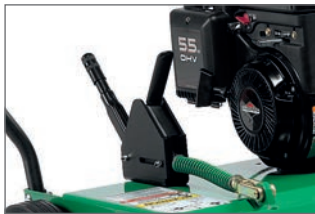

**Heavy Duty Depth Adjustment**  
Save on blade wear when compared to  
pre set adjustments that may promote  
premature flail wear. + 12 mm to - 25 mm.



**PR Flail Reel**  
Heat treated and tempered blades stand  
up to heavy use. Standard on PR Series,  
can be ordered separately. (350112)



**Foldable Handles**  
Great for storage, transport  
and longer life.

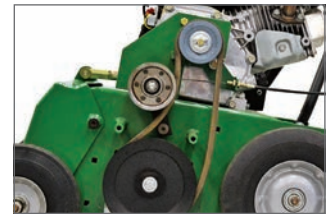

**Premium Construction**  
Steel pulleys, easy to adjust idler  
and easy to change belt contribute to  
long life. Protected by a steel guard.

## Accessories

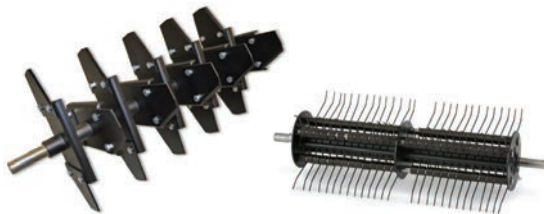

**Vertislicing Reel**  
Perfect for thinning running  
grasses, improving drainage  
and overseeding.  
(350252 / 350113)

**Spring Tine Reel**  
Efficiently removes thatch  
where sprinkler heads or other  
objects may be a concern.  
(350355-S)



**Overseeder Conversion Kit**  
Convert your Power Rake to an Overseeder.  
(350328)

#### USE / LEVEL

#### SMALL - MEDIUM PROPERTIES

#### PROFESSIONAL / COMMERCIAL

##### CR Series

##### PR Series

CR550HCEU

CR550H

PR551V

PR550H

#### ENGINE

	Honda	Honda	Vanguard™	Honda
Engine Make	Honda	Honda	Vanguard™	Honda
Engine Model	GC160	GX160	160	GX160
Performance kW [HP]	3,74 [5,0]**	4,1 [5,5]**	3,7 [5,0]*	4,1 [5,5]**
Displacement (cc)	160	163	169	163

#### POWER RAKE

	51 / 20"	51 / 20"	51 / 20"	51 / 20"
Rake Width (cm/inch)	51 / 20"	51 / 20"	51 / 20"	51 / 20"
Drive Type	Push	Push	Push	Push
Rake depth (cm)	0,3 - 1,3	0,3 - 1,3	0,3 - 1,3	0,3 - 1,3

#### DIMENSIONS / WEIGHT

	59	57	67,7	72
Weight (kg)	59	57	67,7	72
Length x Width x Height (cm)	98 x 72 x 119	98 x 72 x 119	116 x 67 x 119	116 x 67 x 119

#### ACCESSORIES

CR Vertislicing Reel (350252)	•	•		
PR Vertislicing Reel (350113)			•	•
Spring Tine Reel (350355-S)			•	•
Overseeder Conversion Kit (350328)			•	•

\* All power levels are provided by Briggs & Stratton. \*\* All power levels are provided by Honda.



Auto Drop™ system

Model shown:  
OS553V

### OS500 Series

OS553V, OS552H

The OS500 Push Series, powered by a Vanguard™ or Honda engine comes with a 51 cm / 20" VertiCut delta reel that creates the ideal environment for seed to soil contact and high germination rates. This overseeder conserves seed with Billy Goat's exclusive Auto Drop™ feature by automatically starting or stopping seed drop with bale engagement and disengagement conserving seed and preventing seed spilling. The heavy-duty bale controls both seed release and blade engagement. Select the correct drop rate without all the guesswork.

The 11,3 kg capacity front mounted poly seed box won't rust or dent. On board instructions are conveniently mounted under the lid to help set seed application rates. Premier wheels, bale, frame and bearings offer long life and durability.

With optional flail or spring tine reels, the OS500 Series easily converts to a power rake, making this an extremely versatile machine and an excellent investment.



Auto Drop™ system and floating cutting head

### OS900 Series

OS901SPH

Billy Goat's OS900 Self Propelled Series reduces fatigue associated with pushing and features intuitive forward and reverse operator controls. The unique blade design reduces thatch pick-up and improves blade life due to its sharpened leading edge and attack angle combined with a new foot actuated height adjust that raises and lowers the reel effortlessly, providing more blade depth.

This Honda powered overseeder is 56 cm / 22" wide with an exclusive 11-blade slicing reel that floats along contours of turf increasing seed to soil contact and improving germination rates. Infinite depth adjustment of the slicer blades promotes longer blade life vs. presets. Seed settings are found on board for operator convenience.

The unit comes standard with a 13,6 kg seed box that is generously elevated above the turf to eliminate any clogging that may occur from moisture and Billy Goat's exclusive Auto Drop™ system.





## How Does An Overseeder Work?



The hopper drops the seeds and are sown in the desired amount provided by the setting of the sowing dosage.



The seeds fall into the soil grooves made by the rotor blades and then pushed deep into the blade passage.



With the seed planted, it is recommended to sprinkle the soil with more top soil, fertilize and then pass over with a roller.

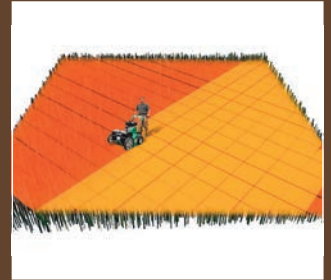

To achieve a better result, it is advisable to overseed by sowing in stages and criss-crossing at 90° angles.

### Auto Drop™ System



Automatically starts and stops seed drop with reel engagement and disengagement, conserving valuable seed.  
Available on the OS500 and OS900 Series.



### Floating Cutting Head



An exclusively designed 56 cm / 22" slicing reel floats, matching with the contours of the ground, therefore increasing seed to soil contact & improving germination rates.  
Available on the OS900 Series.



## Features

### OS500 Series



#### Seed Box

11,3 kg front mounted poly seed box with on-board customer instructions to help set drop rates for various seed. The box / agitator bar won't rust or dent.



#### Fold-n-Go™ Handles

Fold-n-Go™ no tool, no bolt foldable handles with inside bail and padded handles. Great for comfort, storage, transport and long life.



#### Heavy Duty Wheels

Heavy-duty wheels with steel rim and roller bearings stand up to the most demanding customers and applications.

### OS900 Series

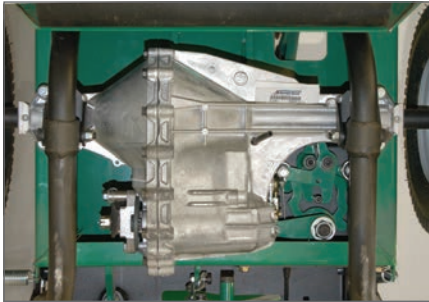

#### Hydrostatic Transmission

Self propelled with intuitive forward & reverse drive controls eliminate pushing to reduce fatigue. Simple auto release switch for transport in off position.



#### Dual Belts

The rotor is drive by dual belts to ensure a longer service life. In the event of a break in one of the two straps, the machine is still able to complete the job.



#### Elevated Seed Box

Prevents moisture from clogging the seed drop and provides excellent visibility. Axle driven seed agitator eliminates belts and tyre-on-tyre systems.



#### Blade

Provides improved slicing, reduced thatch pick-up and longer life due to sharpened leading edge, design, attack angle and new height adjust. Available as an accessory (351290).

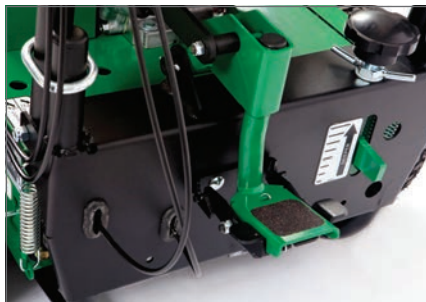

#### Foot Pedal

Available as standard on OS901 models, the foot actuated height adjust raises and lowers the reel effortlessly and provides more blade depth. Available as an accessory for older OS900 Series models (351611).



#### Fold-n-Go™ Handles

No tool, no bolt, foldable handles are great for storage, transport and long life.





## Accessories

### OS500 Series

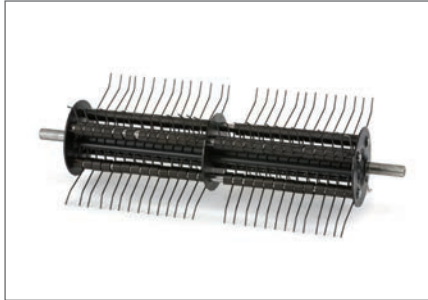

#### Spring Tine Reel

Efficiently removes thatch with a softer touch where sprinkler heads or other objects may be a concern.  
(350355-S)

### OS900 Series



#### Clear Seed Box Cover

Convenient visibility to seed level.  
(351617)



#### Chariot

Reduces operator fatigue.  
(351601)

USE / LEVEL	SMALL - MEDIUM PROPERTIES		LARGE PROPERTIES
	OS500 Series		OS900 Series
	OS553V	OS552H	OS901SPH
<b>ENGINE</b>			
Engine Make	Vanguard™	Honda	Honda
Engine Model	160	GX160	GX270
Performance kW [HP]	3,7 [5,0]*	4,1 [5,5]**	6,6 [9,0]**
Displacement (cc)	169	163	270
<b>OVERSEEDER</b>			
Working Width (cm/inch)	51 / 20"	51 / 20"	56 / 22"
Drive Type	Push	Push	Self Propelled
Transmission Type		-	Hydrostatic
Working depth (cm)	0,3 - 1,3	0,3 - 1,3	0,3 - 1,3
Seed box capacity (kg)	11,3	11,3	13,6
<b>DIMENSIONS / WEIGHT</b>			
Weight (kg)	72,7	81	147
Length (cm)	116	116	148
Width (cm)	67	67	78
Height (cm)	119	119	117
<b>ACCESSORIES</b>			
Spring Tine Reel (350355-S)	•	•	
Clear Seed Box Cover (351617)			•
Chariot (351601)			•
Blade (351290)			•

\* All power levels are provided by Briggs & Stratton. \*\* All power levels are provided by Honda.



Compact, easy to use  
Drum Aerator

Ideal for  
hire  
companies

Model shown:  
AE401H

### AE401 Drum Series

AE401H, AE403V

This mechanical 48 cm / 19" wide aerator eliminates cumbersome filling of a conventional centre drum found on other units on the market, which are prone to wear, vibration and damage.

Billy Goat's outboard drive wheels also eliminate centre wheel slip and abuse from ramp loading with the tines engaged. Instead of bulky steel weights, water weight is positioned directly over the tines for better aeration depth.

Operators love the softest drive and tine engagement and the exclusive Lift N Lock™ feature allows the tines to be raised by simply lifting up on the handle.

The Fold-n-Go™ handles and the tilt up serviceability make service and transport convenient and simple.







## The Benefits of Aeration

The purpose of aeration is to create better conditions for the exchange of air and water in the soil, improving the penetration of water and fertilisers in the soil.

If turf is trampled and walked over continuously, the lawn develops a compact surface that leads to degradation of the lawn surface.



## Features



### Outboard Drive Wheels

Eliminate both centre wheel slip and abuse from ramp loading with the tines engaged.



### Single Bolt Tine Fastener

Rock solid and easy to service.



### Tine Engagement and Lift N Lock™ Disengagement

For best in class comfort and productivity.



### Water Tank

Proprietary water tank eliminates bulky side weights. 23 litre capacity.

### Easy to Store and Service

Tilt up serviceability plus Fold-n-Go™ handles are excellent for transport and storage and fold without tools.

## Accessories



### Solid Steel Tines

Excellent for improving drainage or for other no-plug applications. Sold as a set. (360394-S)



**Cam-driven  
Aerator**



Model shown:  
PL1803V

**PLUGR® 18**

PL1803V, PL1801H

This compact 46 cm / 18" aerator is ideal for smaller property aeration or hire companies and features reciprocating cam tines that propel the unit forward and drive cores up to 7 cm deep. The unit is simple to operate for homeowners, easy to steer without lifting and requires no add-on weights.

The easy folding handle allows for compact transport and storage. Only four tines and no chains along with a no-tool removable cover make for easy maintenance. Powered by reliable Vanguard™ or Honda engines.

**PLUGR® 25 Hydro Drive**

PL2501SPH, PL2501SPV

For the best combination of productivity, operator comfort, superior aeration results, variable hole density and remarkably low maintenance in its class, consider our 64 cm / 25" Hydro-Drive aerator. Best in class controls offer the same intuitive, variable speed fingertip hydro-drive innovation as found on the reliable Billy Goat hydro-drive Brush Cutter, Overseeder and Sod Cutter.

The Patent Pending EZ Drop™ tine system has a one-step tine engagement lever from the handle that quickly drops and engages the tines when the lever is depressed or disengages the tines when the lever is released to pass over obstacles in the aeration path for uninterrupted aeration. It also features "in-ground" steering for unmatched maneuverability, ergonomics, ease of turning, improved production, reduced downtime and turf repair when compared to drum aerators.

**Cam-driven  
Hydro Drive Aerator**



Model shown:  
PL2501SPV



Due to compaction, oxygen, nutrients and water are difficult to infiltrate into the soil. This weakens the grass and depletes the root structure.



The vertical motion of a tine removes small plugs of soil from the ground.

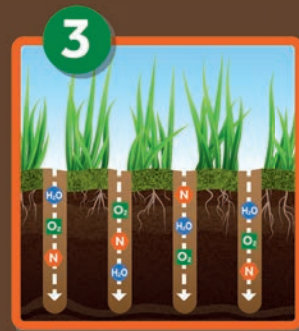

Nutrients, oxygen and water are now able to reach the root structure, creating a stronger lawn.



After treatment, the lawn will be lush and more resistant to diseases or droughts.





## Features

### PL 18 Series



#### Removable Cover

Quick and easy one piece hood removal for access to all components on PL 18 Series.



#### User Friendly Controls

Handle has finger-tip controlled bail for engaging drive / tine with auto stop safety feature on PL 18 Series.



#### Cam-Driven Aerators

Punches tine core depths to 7 cm even in hard soil conditions. Spring loaded rotor assist for aggressive forward motion of the tine rods.



#### Easy Fold Handles

ISO mounted folding handles help reduce vibration and offers fatigue free operation so you can complete more work in less time!

### PL 25 Series

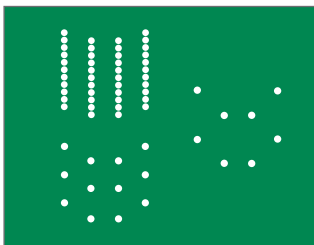

#### VAD™ (Variable Aeration Density)

Creates 2-10x more holes than drum models in one pass. Eliminates double aerating and offers ability to do patch repair and seed bed prep in one pass.



#### Water Weight Tank

Positioned directly over tines for better aeration depth and wheel traction in drier conditions. Full tank capacity is 18 litres.



#### Patent Pending EZ Lift™ Rear Foot Pedal

Conveniently lifts and locks tines for transport or when reversing.



#### Simple, Intuitive, Hydro Drive Controls

Variable speed self-propelled rear wheel drive & front casters allow you to feather the speed with finger tip control. Reduces fatigue, increases productivity and provides enhanced traction while aerating on slopes. Reverse feature (with tines up) for added maneuverability and ease of loading/unloading.



#### Patent Pending EZ Drop™ Tine Engagement

Depressing the orange tine lever releases the tines from the lifted locked position and engages the tining action. When the tine engagement handle is released, tining action stops and the tines drag across obstacles in the aeration path for uninterrupted aeration and increased productivity (as shown, above right).



#### No Tool, Flip-Up Hood

For best in class access to the inside of the machine for easy service plus improved belt access.



**PL18**

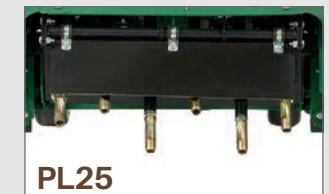

**PL25**

#### Tensile Hardened Thin Wall Tines

Simple, durable screw-in design makes service simple.

Four tines on PL 18 Series and six tines on PL 25 Series.

## Accessories, Assorted Tine Sizes and Styles



#### Service Kits

Common replacement parts for your PLUGR® Series Aerators.  
(PLUGR® 18 - 382024 - 4 required)  
(PLUGR® 25 - 382605 - 6 required)



**3/8"**  
**(9,5 mm)**  
Hollow.  
(331150)



**3/8"**  
**(9,5 mm)**  
Solid.  
(381151)



**7/8"**  
**(22 mm)**  
Solid.  
(381149)



**5/8"**  
**(16 mm)**  
Hollow.  
(381057)



**Zoysia**  
**(44 mm)**  
Hollow.  
(381152)





Cam-driven, hydrostatic transmission

### HYDRO Series

AE1300HEU

This machine combines true 76 cm / 30" wide aeration and speed up to 6,9 km/h. That is 59% faster than a 66 cm / 26" drum. Plus no more tine lifting during turning, capable to aerate in reverse, do trim and edges with ease and significantly improve hole quantity and quality.

Variable Aeration Density (VAD™) from 8 to 48 holes per square metre in one pass and variable hydrostatic drive for aeration in both forward and reverse.

The FLEXTech™ arms make the core depths up to 2x that of drums. The In-Ground Turning feature provides unmatched manoeuvrability, ergonomics, ease of turning, improved production, reduced downtime and turf repair when compared to drum aerators.







## Features

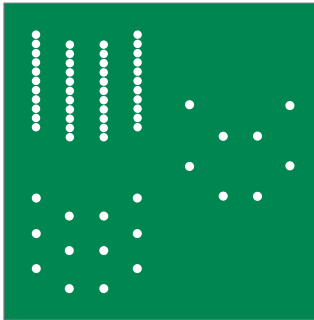

### VAD™ (Variable Aeration Density)

Creates 2-10x more holes than drum models in one pass. Eliminates double aerating and offers ability to do patch repair and seed bed prep in one pass.



### FLEXTech™ Arms

Independently acting arms are durable and forgiving for unmatched reliability. Reciprocating action drives core depths up to 2x that of drums. Reduces call backs and / or rework regardless of soil condition.

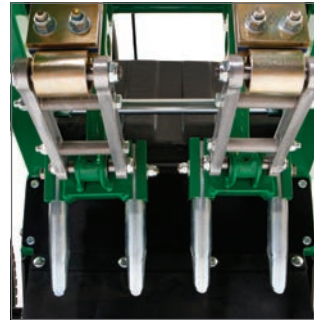

### Fast Tine Service

Only 8 tines and 4 bolts are easily accessed for 10% of the time needed to service 40+ tine, 2-bolt drum units.



### 38 cm / 15" Tyres

This unit has 38 cm / 15" tyres and a 89 cm / 35" wheel base to accommodate slopes up to 20-degrees.



### In-Ground Turning

Provides unmatched manoeuvrability, ergonomics, ease of turning, improved production, reduced downtime and turf repair when compared to drum aerators.



### Reverse Aeration

The AE1300HEU allows aeration in reverse for even more productivity.



## Accessories



### Chariot

For larger open area aeration such as sports fields. (362600)



### Solid Steel Tines

Excellent for improving drainage or for other no-plug applications. Sold as a set (362611).



**Towable Drum Aerator**

Model shown with optional water containers

**TOWABLE 48 Series**

AET48

For larger property aeration, the tow behind AET48 is the ultimate in productivity and flexibility.

The standard 122 cm / 48" modular unit easily configures down to 61 cm / 24" and features interchangeable parts. Each 61 cm / 24" unit has four tine stars with six tines each that core up to 8 cm deep. It cuts service time with single bolt tine fastener.

The AET48 aerator can be configured up to 182 cm / 72" wide with the optional expansion kit.

Optional water containers eliminate bulky steel weights, and are positioned directly over the tines for better aeration depth.



**Towable Drum Aerator**

Will accept concrete counterweight blocks

**TOWABLE 60 Series**

AET60

At up to four acres an hour (1,6 ha per hour), the tow behind AET60 maximizes large property aerations and configures to widths of 91 cm / 36", 122 cm / 48" or 152 cm / 60" with a simple flip up or down of the aerator's wings. This unit weighs 199,6 kg without supplemental weights for deep, hard soil aeration.

For ultimate manoeuvrability, the AET60 also features swivelling tine assemblies (when used with 3-point hitch). It mounts to a standard tow bar or category 1, 3-point hitch, runs up to 8 km/h, and pulls behind any type of tow vehicle (20 HP or more). This unit provides a quality 15,2 cm x 17,8 cm (6" x 7") aeration pattern up to 10,2 cm / 4" deep. Manual jack lifts and lowers tines with two pneumatic wheels for transport.





## Features & Accessories

### TOWABLE 48 Series



#### Tine Engagement Bar and Footpad

Engage tines by stepping on the footpad. Disengage by pulling out the spring loaded lever.



#### Pillow Block Bearings

With grease fittings reduce wear and downtime for maintenance.

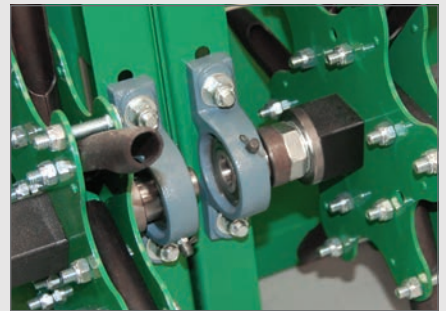

#### Single Bolt Tine Fastener

Rock solid and easy to service.



#### Easy Fill & Drain Water Containers

Weigh over 19 kg each when filled.  
Two containers per 61 cm / 24" unit.  
Requires 4 containers. (361100)



#### Tilt Up Serviceability

"O" ring chain, pillow block bearings and replaceable tine stars for best in class serviceability. Four stars per section, with 6 tines, each core up to 8 cm deep.



### TOWABLE 60 Series



#### Category 1, 3-Point Hitch Mounting

Tines swivel for 3-point hitch mounting.

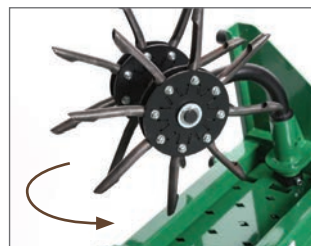

#### 80 Hardened Steel Tines

Provides more efficient extraction of plugs. Tine wheels swivel for superior manoeuvrability (when used with 3-point hitch).

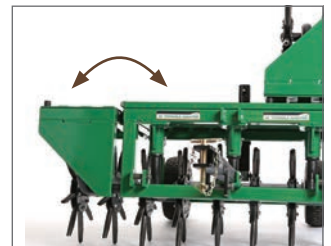

#### Foldable Wings

Wings raise and lower for desired aeration width: 91 cm / 36", 122 cm / 48" or 152 / 60" cm.



#### Manual Lift

Raise and lower tines with ease.



## Ground Care - Aerators

USE / LEVEL	DRUM		RECIPROCATING CAM	
	AE401 Series		PLUGR®18 Series	
	AE401H	AE403V	PL1803V	PL1801H

ENGINE				
Engine Make	Honda	Vanguard™	Vanguard™	Honda
Engine Model	GX120	160	160	GX120
Performance kW [HP]	2,9 [4,0]**	3,7 [5,0]*	3,7 [5,0]*	2,9 [4,0]**
Displacement (cc)	118	169	169	118

AERATOR				
Working Width (cm/inch)	48 / 19"	48 / 19"	46 / 18"	46 / 18"
Tine Type	Drum	Drum	Reciprocating Cam	Reciprocating Cam
Tine Depth (cm)	8,9	8,9	7	7
Number of Tines	24	24	4	4
Tine pattern (cm)	12 x 18	12 x 18	6,5 x 19	6,5 x 19
Drive Type	Self Propelled	Self Propelled	Self Propelled	Self Propelled
Transmission Type	One Gear	One Gear	-	-
Wheel Type	Semi-Pneumatic	Semi-Pneumatic	Semi-Pneumatic	Semi-Pneumatic

DIMENSIONS / WEIGHT				
Weight (kg)	110	114	110	109
Length (cm)	145	145	145	145
Width (cm)	74	74	61	61
Height (cm)	133	133	100	100

ACCESSORIES				
Solid Steel Tines Set (360394-S)	•	•		
Solid Steel Tines Set (362611)				
Tines 3/8" (9,5 mm) Hollow (381150)			•	•
Tines 3/8" (9,5 mm) Solid (381151)			•	•
Tines 7/8" (22 mm) (381149)			•	•
Tines 5/8" (16 mm) (381057)			•	•
Zoysia Transfer (44 mm) (381152)			•	•
Service Kit 18 (380204)			•	•
Service Kit 25 (382605)				
Chariot (362600)				
Weight Jugs - 4 Required (361100)				
Expansion Kit 24" (61 cm) (361273)				



\* All power levels are provided by Briggs & Stratton. \*\* All power levels are provided by Honda.





Hydrostatic transmission

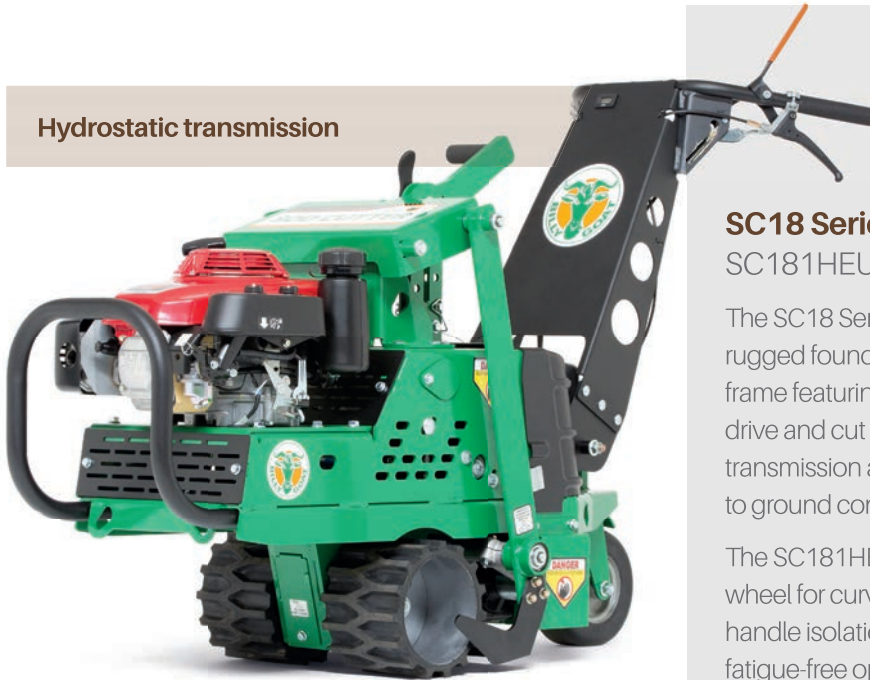

Model shown: SC181HEU

### SC18 Series

SC181HEU, SC181HG EU (Golf Wheels)

The SC18 Series sod cutter is built upon the most rugged foundation in the industry with a superstructure frame featuring 23 kg of steel and supports a robust drive and cut system. A variable speed hydrostatic transmission allows operators to match cutting speed to ground condition in both forward and reverse.

The SC181HEU comes standard with a rear caster wheel for curved cuts and locks for straight cutting and handle isolation mounts absorb vibration for smooth, fatigue-free operation. Other user-friendly features include an hour meter, heavy-duty front bumper bar and six convenient tie-down points.

The SC181HG EU features a specially designed wheel tread for golf applications (see picture), ideal for softer touch and shallow cut applications.

Coupled to Honda power with a 3-year warranty, Billy Goat's 46 cm / 18" hydro sod cutter will be a favourite for irrigation, landscape, hardscape, sports field, flatwork and golf customers.







## Features



**Unique Paddle-Style Drive Wheels**  
SC181HEU model. For landscape applications. Designed to shed mud in wet conditions and grip in dry for improved cutting in all conditions.



**Wheel Tread for Golf Applications**  
SC181HGEU model. Ideal for softer touch, bent grass and shallow cut applications.



**Tie Down Points**  
Convenient tie-downs make machine transport safe.



**Rear Swivel Caster**  
Perfect for curved work or making turns at the end of a pass. Locks for straight cutting.



**Vented Housing and Service Doors**  
Provides increased venting for cool operation. Three easy access service doors located at front / back of machine offer convenient access for servicing.



**Set and Forget™ Blade Depth Adjustment**  
Single lever and clamp at user's operating position adjusts simply, saving time and providing precise cutting depths to 6 cm.

USE / LEVEL	PROFESSIONAL / COMMERCIAL	
	SC18 Series	
	SC181HEU	SC181HGEU
<b>ENGINE</b>		
Engine Make	Honda	Honda
Engine Model	GXV160	GXV160
Performance kW [HP]	4.1 [5,5]**	4.1 [5,5]**
Displacement (cc)	163	163
<b>CUTTER</b>		
Cutting Width (cm/inch)	46 / 18"	46 / 18"
Cutting Depth (cm)	6.3	6.3
Drive Type	Self Propelled	Self Propelled
Transmission Type	Hydrostatic	Hydrostatic
Transmission Brand & Model	HydroGear RT310	HydroGear RT310
Wheels	Traction Wheels	Golf Wheels
<b>DIMENSIONS / WEIGHT</b>		
Weight (kg)	179	179
Length (cm)	162	152
Width (cm)	67	67
Height (cm)	98	98



\*\* All power levels are provided by Honda.



# Meadow and brush cutting the easy way

The Billy Goat brushcutters are made for cutting through overgrown bush, fields, clearing meadows or hiking trails. It doesn't matter how much area you have to mow, with our walk behind and sit-on brushcutters we always offer a suitable solution. All the units carry rigid mowing decks with heavy duty spindles. Combined with a powerful engine, no job is too tough.

The ergonomic controls make these brushcutters a perfect partner in the harshest of environments.









Model shown:  
BC2600ICMEU

**Mechanical transmission.  
Ideal for meadow work**



Model shown:  
BC2601HH

**Hydrostatic drive.  
Ideal for rough terrain,  
hills and high brush**

**Electric start option**

### **BC Series - Fixed Deck**

BC2600ICMEU, BC2601HM

The 66 cm / 26" wide fixed deck commercial-duty brush cutter provides excellent stability in deep vegetation.

The mechanical transaxle, featuring 3 speeds forward and 1 reverse, is ideal for clearing meadows and fields or cutting paths and trails wherever dense brush and weeds present a clean-up challenge.

The heavy-duty blade spindle is reinforced on four sides to tackle the toughest cutting conditions, including thick brushes, grass and weeds over 180 cm tall, and saplings up to 5 cm diameter. For operator comfort and high productivity, forward and reverse controls are at your fingertips.

The fixed deck brushcutters are powered by trusted Briggs & Stratton and Honda engines.

### **BC Series - Pivoting Deck**

BC2601HH, BC2601HEBH

Step up to the heavy-duty brush cutter power of the BC Pivoting Deck Series and dramatically improve your productivity and profitability.

The BC26 has a 66 cm / 26" wide pivoting deck with higher tip speed for improved speed and cut quality. Engineered to glide over uneven terrain, the pivoting brush deck hugs the ground for a better cut. This minimizes scalping and improves traction by keeping the weight of the machine on its drive wheels.

This nature-taming performer comes standard with a Tuff Torq™ variable hydrostatic transmission featuring fully Automatic Controlled Traction (ACT), offering superior traction in wet or uneven conditions.

Both brushcutters can cut saplings and brushes - all at a rate of just under an acre of brush per hour. The BC2601HEBH is equipped with a powerful Honda engine with electric start.





## Features

### BC Series - Fixed Deck



#### Fixed Rear Discharging Deck

Does not articulate and pull, snag on hills, holes or uneven ground. Provides excellent stability in deep vegetation. Rigid Deck.

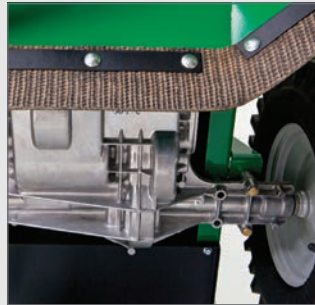

#### Heavy-Duty Mechanical Transaxle

Combines the transmission and differential into one sealed package with no linkages to snag on brush. Three speeds and reverse.



#### Heavy Duty Blade Spindle

Reinforced in four directions for maximum durability and safety, so you can keep cutting in the harshest conditions.



#### Ergonomically-Angled Control Handles with Padded Grips

Intuitive drive controls make it easier to move forward and reverse. Wide handles with padded grips and guards for maximum protection and leverage in deep brush.

### BC Series - Pivoting Deck



#### Pivoting Rear Discharging Deck

+/- 12 degree and 66 cm wide pivoting deck with proprietary return to neutral is engineered to glide over uneven terrain and deep brush.

#### Wide Tyres

Wider tractor tyres for better traction and pulling power.



**Tuff Torq™ Hydrostatic Transaxle**  
With ACT (Automatic Controlled Traction) is fully automatic, sensing when the rear wheel starts to spin, locking the wheel to provides superior traction on hills or in wet and uneven conditions.



**Rubber Rear Deck Trim**  
Allows for easier stump clearance in reverse.



**Intuitive Drive Controls & Handles with Padded Grips**  
Best in class control package allows the user to feather in forward and reverse directly from the handles - no shifting required.

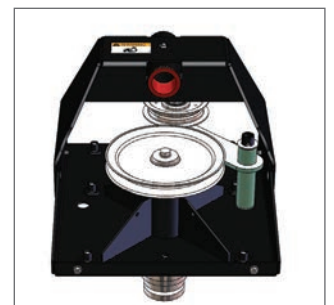

**Heavy Duty Blade Spindle**  
Reinforced in four directions for maximum durability and safety, so you can keep cutting in the harshest environments.



**Swivelling Front Caster Wheels**

The swivelling caster wheels provides stability to the pivoting mower deck to cut bushes and weed evenly at higher heights up to 9,5 cm tall.

**BC Series - Pivoting Deck, Swivel Wheels**  
BC2601HHC

The BC2601HHC offers all the great features of the BC Series with pivoting deck and variable Tuff Torq™ hydrostatic transmission but has lockable front caster wheels to help hold hillsides. The caster wheels allow the brush cutter more mobility when being turned.

Ergonomically-angled handles with padded grips offer comfort and protection. Never take your hands off the machine to shift gears with conveniently located controls. It is equipped with a powerful Honda engine.

**Hydrostatic drive & swivel wheels.**  
Ideal for rough terrain, hills and high brush







USE / LEVEL	ROUGH TERRAIN, HILLS & HIGH BRUSH				
	BC Series - Fixed Deck		BC Series - Pivoting Deck		BC Series - Swivel Wheels
	BC2600ICMEU	BC2601HM	BC2601HH	BC2601HEBH	BC2601HHC

ENGINE					
Engine Make	Briggs & Stratton	Honda	Honda	Honda	Honda
Engine Model	Intek™ Series	GXV390	GXV390	GXV390	GXV390
Performance kW [HP]	7,6 [10,3]*	9,7 [13,0]**	9,7 [13,0]**	9,7 [13,0]**	9,7 [13,0]**
Displacement (cc)	344	390	390	390	390
Starting	Recoil Start	Recoil Start	Recoil Start	Electric Start	Recoil Start

BRUSHCUTTER					
Cutting Width (cm/inch)	66 / 26*	66 / 26*	66 / 26*	66 / 26*	66 / 26*
Height of Cut (cm)	9,5	9,5	9,5	9,5	9,5
Height of Cut Adjustment	Fixed	Fixed	Fixed	Fixed	Adjustable
Drive Type	Self Propelled	Self Propelled	Self Propelled	Self Propelled	Self Propelled
Transmission Type	Gearred	Gearred	Variable Hydrostatic	Variable Hydrostatic	Variable Hydrostatic
Gears Forward	3	3	Infinite	Infinite	Infinite
Gears Reverse	1	1	Infinite	Infinite	Infinite
Diff Lock	-	-	Automatic Controlled Traction	Automatic Controlled Traction	Automatic Controlled Traction

DIMENSIONS / WEIGHT					
Weight (kg)	143	144	147	152	147
Length (cm)	183	183	183	183	203
Width (cm)	78	78	78	78	78
Height (cm)	121	121	121	121	121

\* All power levels are provided by Briggs & Stratton. \*\* All power levels are provided by Honda.



Model shown:  
BCR3626BVECE

**4WD - Professional use**  
Ideal for rough terrain, hillsides and high vegetation

### Outback® Series

BCR3626BVECE, BCR4326BVECE

Billy Goat Outback® ride-on brushcutters have set the highest standard for professional brush cutting equipment on the market. The Outback® 4WD Rider offers unique features and benefits to combat the most demanding conditions.

When rough and overgrown areas limit the use of conventional mowers, this robust machine delivers the ultimate performance for these conditions.

The Outback® 4WD Rider has been designed with a low center of gravity in combination with a four wheel drive system that enables it to tackle those hard-to-reach places that wouldn't have been accessible to traditional machines.

The spacious platform provides sufficient space and comfort for the operator. The heavy duty mower deck is equipped with swing-back cutter blades that swing away when accidental contact is made with a solid object. These features help to protect the mower deck and cutter blades from accidental damage.

Look no further than the Billy Goat Outback® when you are looking for the ultimate brush cutting machine.

## VANGUARD®



### Vanguard™ EFI engine

By adding closed-loop EFI, Vanguard™ engines deliver easier starting and fuel savings of up to 25%\* over carburetted equivalents. Vanguard™ EFI systems also deliver optimized starting, including cold & hot restart and chokeless starting.

\* Closed-loop EFI system fuel savings may vary based on cutting conditions and other factors.





## Features



### Transmission Oil Cooler

A remote transmission oil cooler controls the transmission oil temperature even in the toughest conditions, reducing thermal oil breakdown for an extended operating life of the system.



### ROPS Structure

A certified ROPS (Roll Over Protection Structure) with safety belt protects the machine and operator for rolling over and can fold 180 degrees backwards to allow for easier loading inside a van or trailer.



### User Friendly Dashboard

The operators compartment features a dashboard with control and warning lights, electric PTO engagement switch with soft start function, steering wheel with tilt-function and spinner knob, cruise control switch and a parking-brake lever.

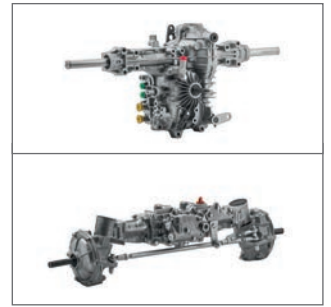

### Drive System

The Tuff Torq™ 4WD system automatically controls the output to all drive wheels. Combined with a manual locking differential, this 4WD system provides all the traction you need in challenging terrain.



### Durable Mower Deck

The strong fabricated rear discharge deck discharges grass clippings rearwards. Replaceable swing-back cutter blades reduce accidental blade damage, with flip-up lids on the side of the deck providing easy access to the swing-back cutters when needed.



### Drive Wheels

Large drive wheels with agricultural tread ensure sufficient grip. The pivoting front axle allows all four driven wheels to remain in contact with the ground for maximum traction.

USE / LEVEL	ROUGH TERRAIN, HILLSIDES & HIGH VEGETATION	
	Outback® Series	
	BCR3626BVECE	BCR4326BVECE

### ENGINE

Engine Make / Model	Briggs & Stratton Vanguard™ 810cc EFI, V-Twin	Briggs & Stratton Vanguard™ 810cc EFI, V-Twin
Engine Performance	26 gross HP (SAE J1940) / 810cc*	26 gross HP (SAE J1940) / 810cc*
Air Filtration	Donaldson® 2 stage cyclonic air cleaner	Donaldson® 2 stage cyclonic air cleaner
Fuel	Petrol (up to 10% ethanol)	Petrol (up to 10% ethanol)
Fuel Tank Capacity	16 Litre	16 Litre

### BRUSHCUTTER

Cutting Width (cm/inch)	92 / 36"	110 / 43"
Height of Cut (cm)	5 - 13,5 cm (in transport mode max. 16 cm)	5 - 13,5 cm (in transport mode max. 16 cm)
Height Adjustment	Adjustable in 5 positions, one transport position	Adjustable in 5 positions, one transport position
Drive System	Tuff Torq 4WD system with K664 hydrostatic transaxle and KXH10M front axle	Tuff Torq 4WD system with K664 hydrostatic transaxle and KXH10M front axle
Transmission Cooling	Remote Oil Cooler with Electric Fan	Remote Oil Cooler with Electric Fan
Parking Brake	Internal Transaxle	Internal Transaxle
PTO Clutch	Warner Electro Magnetic Clutch	Warner Electro Magnetic Clutch
Deck Drive System	B-section Belt with Soft Start Function	B-section Belt with Soft Start Function
Forward Speed (km/h)	0 - 9,5	0 - 9,5
Reverse Speed (km/h)	0 - 7,5	0 - 7,5
Differential Lock	Standard, Lever Activated	Standard, Lever Activated
Front Wheel (inch)	16 x 6,50 - 8, agricultural tread	16 x 6,50 - 8, agricultural tread
Rear Wheel (inch)	20 x 10,00 - 8, agricultural tread	20 x 10,00 - 8, agricultural tread
Seat	Adjustable Contoured Seat with Armrests and Seat Belt	Adjustable Contoured Seat with Armrests and Seat Belt
Lights	Halogen Front Lights and LED Contour Light Front and Rear	Halogen Front Lights and LED Contour Light Front and Rear
Display Control Lights	Mower Deck Engagement, Parking brake, Oil Pressure, Battery, Fuel Level Warning, Cruise Control, Hour Meter	Mower Deck Engagement, Parking brake, Oil Pressure, Battery, Fuel Level Warning, Cruise Control, Hour Meter

### OTHER INFORMATION

Length x Width x Height (mm)	2350 x 1040 x 1740	2350 x 1160 x 1740
Ground Clearance (mm)	125	125
Wheel Base (mm)	1480	1480
Minium Turning Radius (mm)	1280	1280
Rear Wheel Internal Radius (mm)	750	750
Weight (kg)	403	412
Maximum Inclination (°)	22	22

\* All power levels are provided by Briggs & Stratton.









# Clean up with our vacuums, blowers and debris loaders

From small property residential to large property commercial leaf clean-up, Billy Goat's full line of Debris equipment gets your job done easy and fast.

With the biggest range of vacuums you always find the best machine. The light Force™ blowers are up to 30% lighter and deliver up to 7x the power of a backpack. If you have to manage big amounts of leaves or rubbish, let us convince you by the power of our debris loaders.

Check on the next pages which machine fits your job.





Lightweight, easy to push



Increased power,  
self propelled option

Model shown:  
F1002SPV



Professional use,  
self propelled option

Model shown:  
F1302SPH



### F6 Series

F602V

Billy Goat's F6 Series force blowers feature the next level of performance and productivity in push blowers. Forget the fatigue factor associated with heavy metal machines, this series is a remarkable 30% lighter than comparable steel units making it a breeze to roll around the lawn. Ideal for residential clean up and it is 2,5 times more powerful than a backpack, so you'll get your work done faster with less fatigue.

The F6 Series is equipped with a professional Vanguard™ engine.

### F9 / F10 Series

F902H, F1002V, F1002SPV

Step up to commercial clean up power. This unit is ideal for medium size maintenance contractors and large property owners. The F902H is backed by a 3-year Honda engine warranty.

The F10 Series force blowers offers all the great features of the F9 Series but these 2 models are both equipped with professional Vanguard™ engines with 3 year warranty.

The F1002SPV is self propelled to increase productivity.

### F13 / F14 Series

F1302H, F1302SPH, F1402V, F1402SPV

Professional power and productivity, these force blowers are a favourite for full size landscapers, schools, parks departments, cemeteries, resorts and golf and estate properties.

The F13 Series is available in a push and a self propelled version and is powered by Honda engines.

The F14 Series is also available in a push and a self propelled version and is powered by Vanguard™ engines.





**Key Features:**

All models feature patented Aim & Shoot™ throwing debris farther (pictured left).  
5 year housing warranty on F9 - F18 Series.







## Debris Management - Force Blowers

### Professional use

Model shown:  
F1802SPV



### F18 Series

F1802V, F1802SPV

The ultimate in volume and power! A 15,2 cm discharge with air velocity of just below 320 km/h will blow and push leaves and debris farther so you can clean up faster than with any other blower in our line up.

Both blowers are equipped with professional Vanguard™ V-Twin engines with a 3-Year engine warranty.

AVERAGE LEAF CLEARING TIME	2.000m <sup>2</sup>	4.000m <sup>2</sup>	8.000m <sup>2</sup>
<b>STANDARD EQUIPMENT</b>			
Handheld Blower	5 hrs. 24 mins	-	-
Large Backpack	2 hrs. 45 mins	5 hrs. 29 mins	-
<b>BILLY GOAT FORCE BLOWERS</b>			
F6 Series	1 hr. 12 mins	2 hrs. 23 mins	4 hrs. 46 mins
F9/10 Series	43 mins	1 hr. 26 mins	2 hrs. 52 mins
F13/14 Series	27 mins	53 mins	1 hr. 46 mins
F18 Series	24 mins	47 mins	1 hr. 24 mins

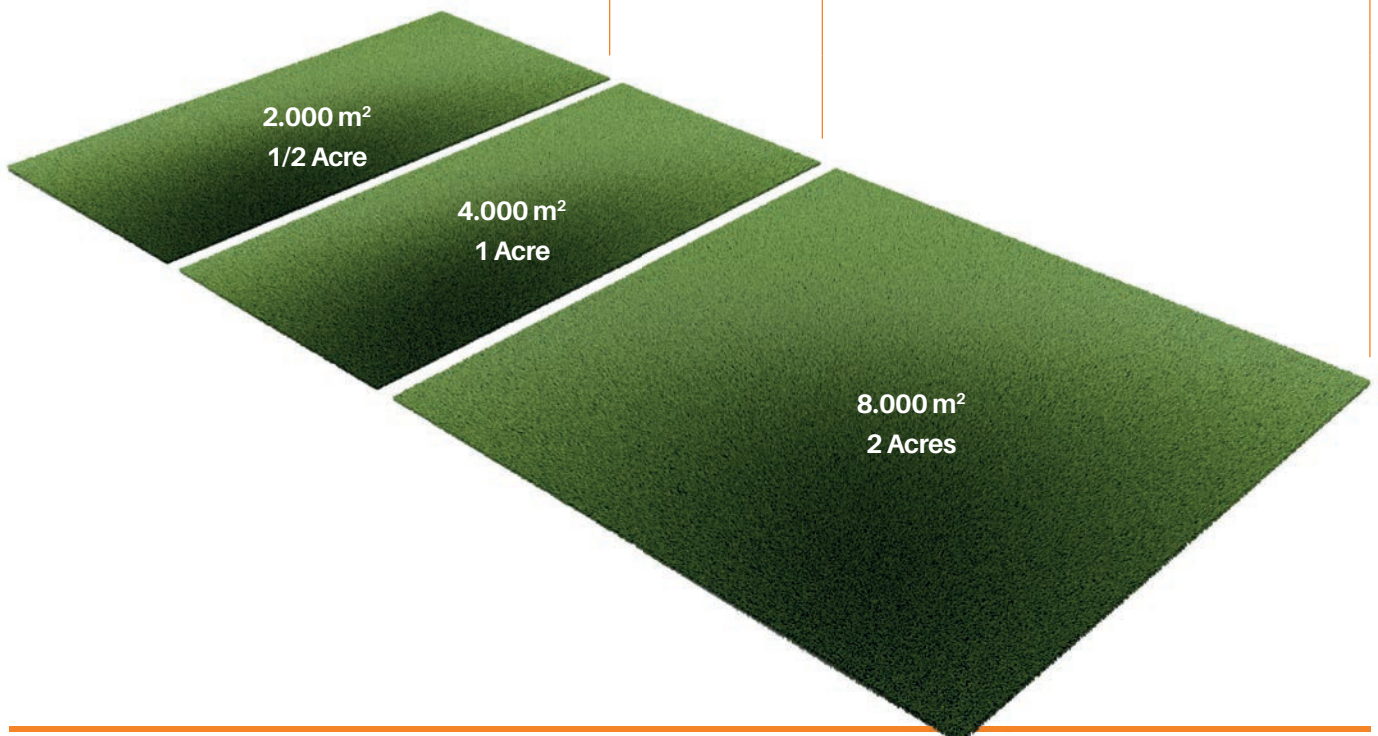





## Features



### Patented Aim N Shoot™

Directs the airflow where you need it most with fingertip control and is lockable for single positions.



### Smooth, Rounded Housing

Eliminates air voids for a smooth, quiet, powerful flow. Proven design won't rust or dent. Backed by a 5-Year housing warranty.



### Quiet Operation

Compared to backpacks and steel blowers, the quiet operation is a welcome relief among users and in neighbourhoods.

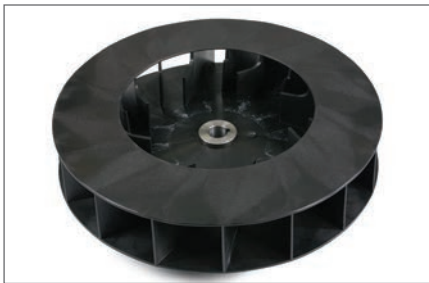

### Advanced Fan Technology

Features a single shot 16-blade closed face fan; twice as many blades as others on the market.



### Self Propelled Blowers

The F10, F13, F14 and F18 Series force blowers all have a self propelled option to increase operator productivity.



### Ergonomic Handles

Easy and comfortable to use.

## Accessories

### F6 Series



### Forward Discharge

Improved design of soft rubber. It is perfect for cleaning along walls and fences. Standard on F9 - F18 Series models. (441130)

### F9 - F10 - F13 - F14 - F18 Series



### Caster Wheel Kit

Allows more manoeuvrability in tight spaces for moving airflow from side to side, without lifting the front wheel. (440293)



### Parking Brake Kit

Locks drive wheels to park the force blower on hill sides. (440140)



### 3m Hose Kit

Fits over nozzle to direct airflow into hard to reach spaces. (441166)



### Quick Hold Down Kit

Quick trailer lock down attachment saves time. (440120)



### Foam Filled Front Tyre

Foam filled tyres cannot be punctured, avoiding costly downtime and tyre replacements. (440279)



## Debris Management - Force Blowers

USE / LEVEL	SMALL		MEDIUM	
	F6 Series	F9 Series	F10 Series	
	F602V	F902H	F1002V	F1002SPV

### ENGINE

Engine Make	Vanguard™	Honda	Vanguard™	Vanguard™
Engine Model	160	GX270	19L2	19L2
Performance kW [HP]	3,7 [5,0]*	6,6 [9,0]**	7,46 [10,0]*	7,46 [10,0]*
Displacement (cc)	169	270	305	305

### BLOWER

Output Diameter (cm)	8.9	10.2	10.2	10.2
Drive Type	Push	Push	Push	Self Propelled
Productivity	2.3 x backpacks	3.8 x backpacks	3.8 x backpacks	3.8 x backpacks
Air Velocity (km/h)	320	320	320	320
Impeller Blades	16	16	16	16
Fan Size (inch [cm])	16 [40,6]	17 [43,2]	17 [43,2]	17 [43,2]
Front Wheel Tyres (inch [cm])	8 [20,3] x 3 [7,6]	10 [25,4] x 3 [7,6]	10 [25,4] x 3 [7,6]	10 [25,4] x 3 [7,6]
Front Tyre Type	Semi-pneumatic	Pneumatic	Pneumatic	Pneumatic
Rear Wheel Tyres (inch [cm])	10 [25,4] x 3 [7,6]	13 [33] x 5 [12,7]	13 [33] x 5 [12,7]	13 [33] x 5 [12,7]
Rear Tyre Type	Pneumatic	Pneumatic	Pneumatic	Pneumatic

### DIMENSIONS / WEIGHT

Weight (kg)	40	65	65	74
Length (cm)	111	143	143	143
Width (cm)	56	74	74	74
Height (cm)	114	114	114	114

### ACCESSORIES

Hose Kit (441166)	•			
Forward Discharge (441130)	•			
Caster Wheel Kit (440293)		•	•	•
Quick Hold Down Kit (440120)				•
Parking Brake Kit (44140)		•	•	•
Foam Filled Front Tyre (440279)				•



\* All power levels are provided by Briggs & Stratton. \*\* All power levels are provided by Honda.





LARGE

F13 Series / F14 Series				F18 Series	
F1302H	F1302SPH	F1402V	F1402SPV	F1802V	F1802SPV

Honda	Honda	Vanguard™	Vanguard™	Vanguard™	Vanguard™
GX390	GX390	400	400	MOD35	MOD35
9,6 [13,0]**	9,6 [13,0]**	13,4 [14,0]*	13,4 [14,0]*	13,4 [18,0]*	13,4 [18,0]*
393	393	408	408	570	570

12,7	12,7	12,7	12,7	15,2	15,2
Push	Self Propelled	Push	Self Propelled	Push	Self Propelled
6,2 x backpacks	6,2 x backpacks	6,2 x backpacks	6,2 x backpacks	7 x backpacks	7 x backpacks
320	320	320	320	320	320
16	16	16	16	16	16
17 [43,2]	17 [43,2]	17 [43,2]	17 [43,2]	17 [43,2]	17 [43,2]
10 [25,4] x 3 [7,6]	10 [25,4] x 3 [7,6]	10 [25,4] x 3 [7,6]	10 [25,4] x 3 [7,6]	10 [25,4] x 3 [7,6]	10 [25,4] x 3 [7,6]
Pneumatic	Pneumatic	Pneumatic	Pneumatic	Pneumatic	Pneumatic
13 [33] x 5 [12,7]	13 [33] x 5 [12,7]	13 [33] x 5 [12,7]	13 [33] x 5 [12,7]	13 [33] x 5 [12,7]	13 [33] x 5 [12,7]
Pneumatic	Pneumatic	Pneumatic	Pneumatic	Pneumatic	Pneumatic

73	76	71	78	81	83
143	143	143	143	143	143
74	74	74	72	74	74
114	114	114	114	114	114

•	•	•	•	•	•
•	•	•	•	•	•
•	•	•	•	•	•
•	•	•	•	•	•



Model shown:  
X3000CE



**Ergonomic Operator  
Platform & Thigh Pad**



### **Hurricane™ Series**

X3000CE, Z3000CE

The zero turn stand-on models are a great addition to the current fleet of walk behind Force™ blowers.

The Hurricane™ Series consists of two stand-on blowers that take clean-up productivity to a whole new level. Both models provide zero turn maneuverability, rapid mount/dismount, seamless operating controls and robust blowing power. The end result is fatigue-free operation and improved productivity for busy operators.

Both stand-on blowers have a spacious operator platform with integrated thigh padding providing excellent comfort. The stand-on feature also allows better visibility, leading to higher quality work.

Air flow is changeable from the operator control panel in three directions - left, right and front. The patented Dual Deflector Air Flow System™ on the left side allows the operator to change the angle of the air flow for deeper, more efficient cleaning of leaves and debris.

The Hurricane™ Series accelerates the clean-up task so more jobs can be completed faster and with less wear on the operator.







## Features



### Professional Engine

The professional Vanguard™ V-Twin engines deliver top reliability, performance and durability. Ideal for commercial applications.



### Quad Control Handle System™

This system offers seamless forward/reverse direction, automatic return to neutral, integrated operator presence control and a self-activating parking brake. Intuitive controls for ease of operation.

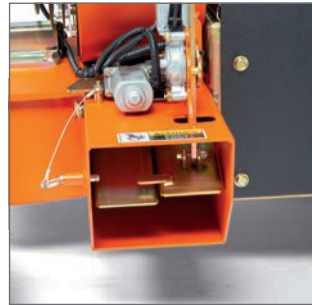

### Dual Deflector Air Flow System™

This system allows the operator to change the angle of the air flow to enhance the deep, more efficient cleaning of leaves and debris. Air flow can be shut down on all three discharges for transport.



### Joystick Deflector Control

The joystick allows the operator full control of the air flow direction, from left, right or forward directions. Pulling back on the joystick closes all deflectors for transport.



### LED Lights

Integrated LED lights in the operator platform allows working and loading into dusk, extending the work day.



### Torsion Mounted Front Axle Assembly

Go over curbs or uneven terrain with ease with the torsion-mounted front axle. Bumps are softened, smoothing out the ride.



### Front & Rear Tie Downs

Convenient tie-down points make machine transport safe.



### Automatic Parking Brake

The Hurricane™ blowers automatically engage an internal parking brake any time the operator leaves the platform.

USE / LEVEL	PROFESSIONAL	
	Hurricane™ Series	

Model Name	X3000CE	Z3000CE
Model Number	5901960	5901958

ENGINE		
Engine Make	Vanguard™	Vanguard™
Engine Model	MOD38	MOD61
Performance kW [HP]	17,16 [23]	26,11 [35]
Displacement (cc)	627	993
Fuel Tank Capacity (l)	38	38

BLOWER		
Transmission	Hydro-Gear® ZT-3100™	Hydro-Gear® ZT-3100™
Drive Train Type	Dual Hydrostatic	Dual Hydrostatic
Number of Speeds	Infinitely Variable	Infinitely Variable
Forward Speed (km/h)	12,8	14,4
Air Velocity (km/h)	266	266
Air Flow (m³/min)	184+	241+
Impeller Diameter (cm)	48	48
Impeller Blades	6	6
Air Discharge Locations	Left, Front, Right	Left, Front, Right
Air Discharge Control	Electric Joystick	Electric Joystick
Front Wheel Tyres (inch)	11 x 4.00	13 x 6.50
Rear Wheel Tyres (inch)	20 x 8.00	22 x 11.00
Parking Brake	Electric, Automatic Engagement	Electric, Automatic Engagement

DIMENSIONS / WEIGHT		
Weight (kg)	338	444
Length (cm)	152	165
Width (cm)	107	114
Height (cm)	137	142

\* All power levels are provided by Briggs & Stratton.



## Debris Management - Leaf & Litter Vacuums

Compact and easy to manoeuvre



### LB Series

LB352

The Little Billy outdoor leaf and litter vacuum, weighing only 26 kg and 51 cm / 20" wide, is a particularly light and manoeuvrable entry level vacuum featuring superior suction. The unit is ideal for vacuuming leaves, grass and garden debris on patios or hard surface areas. Powered by a reliable Briggs & Stratton 500E Series™ engine.

Easy operation



Model shown: KV601SPEU

### KV Series

KV601EU, KV601SPEU

Powerful suction and easy operation make clean up a snap for leaves, seeds, mulch, blooms, branches, litter and debris. Ideal for multi-surface residential and light commercial use, Billy Goat's versatile 69 cm / 27" wide lawn and litter vacuum has variable height adjustment for hard surface or turf work. 30 cm / 12" tyres on the push vacuums and rear wheel drive on the self propelled vacuums makes operation easy, even in hilly environment. The KV Series vacuum are powered by trusted Briggs & Stratton engines.

Integrated chipper



### TKV Series

TKV601SPEU

The 69 cm / 27" TKV Series lawn and litter vacuum offers all the great features of the KV Series but has an integral on-board 5,1 cm / 2" chipper. Now you can add branches to all your leaf, seed, blooms, mulch, litter and debris clean up jobs. The TKV self propelled Honda powered vacuum takes the chore and fatigue out of hilly turf clean up.

**Integrated Chipper** - Now you can add branches to all your leaf, seed, bloom, mulch, litter, and debris cleanup jobs.







## KV / TKV Series Features

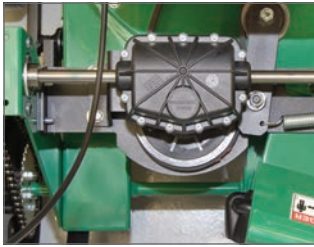

### Robust Transmission

Self-propelled models feature a robust single speed transmission. Great for hilly turf applications.



### Easy Opening of Bag

The hard bottom zipperless bag uses two easy open fasteners for long life and simple unloading. Bottom loading.



### Integral Dust Skirt

Keeps dust down and away from the operator.

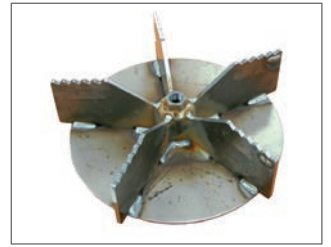

### 5-Blade Serrated Impeller

Maximizes suction, long life time and debris reduction.

## Accessories

### LB Series



**LB Hose Kit**  
10 cm x 210 cm  
(900460)



**LB Turf Bag**  
Turf bag for Little Billy. 105 litre capacity.  
(900722)

### KV / TKV Series



**Caster Wheel Kit**  
Increases manoeuvrability.  
(891128)



**Nozzle Wear Kit**  
Prevents nozzle wear on hard surface applications.  
(891127)



**KV601SPEU with Hose Kit**  
The optional hose kit helps between shrubs, beds and under decks or utilities. With telescopic handle  
(891125)



**Foldable Turf Bag**  
For better dust control. 151 litre capacity.  
(891126)

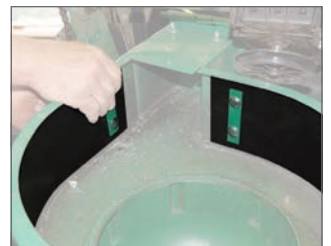

**Liner Sleeve**  
Protects housing in sandy conditions.  
(891134)



**Cover**  
Waterproof.  
(891137)



**Shredder Screen Kit**  
Reduces dry leaves up to 12:1.  
(891153)

Electric start option

Model shown:  
MV601SPEEU  
with optional hose kit



**MV Series**

MV601SPEEU, MV601EU, MV601SPDSEU

Step up to the heavy-duty clean up power of the MV Series 74 cm / 29" wide lawn and litter vacuums.

Designed for both hard surfaces and turf, the MV Series is ideal for larger properties, commercial lots, leaf clean up, hire companies, parks, city streets, school districts or municipal clean up. Powerful 6-blade serrated impeller for maximum suction and debris reduction. Picks up cans, bottles, grass clippings, litter and other debris with ease. Abrasion-resistant composite housing components reduce weight and won't rust or dent.

The MV Series features three Briggs & Stratton powered vacuums. The Briggs & Stratton electric start engine is made for easy starting.





## Features



### 74 cm / 29" Gobbler Door

Adjustable from the operator's position for easy switching between hard surface, turf or hose applications.



### Unique Top Fill Design

Keeps dust out of operator's face and ensures optimum filling.



### Top Loading Bag

Slides in and out on rails for best in class unloading. The 151 litres mesh bag holds up to 23 kg of debris.



### Easy Control of Height

Crank style for optimum performance on turf and hard surfaces.



### 3-Speed Transmission

The MV Series self propelled models are equipped with a 3-gear ultra smooth and durable transmission.



### 36 cm / 14" Wheels

The 14" wheels smooth out the rough areas and make the vacuum manoeuvrable.

## Accessories



### MV Series Hose Kit

MV Series vacuum with optional hose kit attached to the gobbler door. With telescopic handle. Diameter 12,7 cm / 5". Length 305 cm / 10". Model shown: MV601SPEEU. (840116)



### Cover

Waterproof. (891137)



### Caster Wheel Kit

Increases manoeuvrability. (840129)



### Electrostatic DUST SOCK™ Kit

Traps dust for optimum operator and air quality protection. (840263)



### Disposable Bag Liners

Eliminates the extra step of bagging your debris. Pack of 12. (840134)



Model shown:  
QV550HSP with optional hose kit

Low dust, low noise  
with QuietVac™



### QV Series

QV550H, QV550HSP, QV900HSP

Billy Goat's 84 cm / 33" QUIETVAC™ is the world's quietest vacuum. It's unique cyclonic filtration with exclusive Dust Sock™ technology that dramatically reduces dust in dry conditions.

The housing and 6-blade armour plate steel fan combination provide optimum suction power and 12 to 1 debris reduction for composting in dry conditions.

This hard surface machine is ideal for contractor use and municipal clean up applications such as tarmac, school campuses, hospitals, parks, churches, airport pedestrian areas, resorts, city streets and pavements.

The QV Series range consists of one push and two self propelled vacuums, all powered by Honda.







## Features



### QUIETVAC™

As low as 97 LWa and 77 dBa at full rpm and 96 LWa and 76 dBa at 2800 rpm.



### Debris Bag Dust Skirt

The QV Series vacuums are standard equipped with a debris bag dust skirt.



### Turf Bag

Large 136 litres turf bag with 4 hooks. Loading and unloading is fast and easy.



### Powerful Suction

Unique housing and fan system provides the best suction power of any vacuums on the market today.



### Durable Front Casters

Roll smoothly through turns and over uneven surfaces.



### Easy Steering

Thanks to the clutches on the handlebars the QV Series is easy to manoeuvre, even in the most restricted areas.



### Hydrostatic Drive Transmission

The self propelled models have a hydrostatic transmission from 0 ~ 4,8 km/h with infinite forward and reverse.



### Unique Cyclonic Filtration

The cyclonic filtration system, when combined with exclusive DUST SOCK™ technology, dramatically reduces dust in dry conditions, providing the ultimate in operator comfort.

### Electrostatic DUST SOCK™

The DUST SOCK™ acts as a secondary filter lowering the amount of dust that escapes the bag. It is used in dry and dusty conditions only.

## Accessories



### Replacement Bag

Replaces the original vacuum bag. 136 litre capacity. (831612)



### Parking Brake Kit

(831609)



### Collapsible Hose

12,7 x 305 cm (5" x 10") hose; hand extension for best in class ergonomic use; on board storage. (831018)



### Liner Sleeve

Protects housing in sandy conditions. (831610)



## Debris Management - Leaf & Litter Vacuums

USE / LEVEL	SMALL SIZE	LIGHT COMMERCIAL / RESIDENTIAL		
	LB Series	KV Series		TKV Series
	LB352	KV601EU	KV601SPEU	TKV601SPEU

### ENGINE

	Briggs & Stratton	Briggs & Stratton	Briggs & Stratton	Briggs & Stratton
Engine Make	Briggs & Stratton	Briggs & Stratton	Briggs & Stratton	Briggs & Stratton
Engine Model	500E Series**	850 Professional Series**	850 Professional Series**	850 Professional Series**
Performance kW [HP]	2,6 [3,5]	4,5 [6,0]	4,5 [6,0]	4,5 [6,0]
Displacement (cc)	140	190	190	190
Starting	Recoil Start	Recoil Start	Recoil Start	Recoil Start

### VACUUM

Working Width (cm/inch)	51 / 20"	69 / 27"	69 / 27"	69 / 27"
Drive Type	Push	Push	Self Propelled	Push
Transmission Type	-	-	-	-
Housing Material	Composite	Metal	Metal	Metal
Wheels (inch)	8"	12"	12"	12"
Impeller Blades	4	5	5	5
Impeller Type	Non serrated	Serrated	Serrated	Serrated
Bag System	Zipper Bag	Foldable Bag	Foldable Bag	Foldable Bag
Bag Capacity (l)	105	151	151	151

### DIMENSIONS / WEIGHT

Weight (kg)	26	53	60	61
Length (cm)	119	158	158	158
Width (cm)	55	68	68	68
Height (cm)	102	110	110	110

### ACCESSORIES

LB Hose Kit (900460)	•			
LB Turf Bag (900722)	•			
Hose Kit (891125)		•	•	•
Hose Kit (840116)				
Caster Wheel Kit (891128)		•	•	•
Caster Wheel Kit (840129)				
Nozzle Wear Kit (891127)		•	•	•
Liner Sleeve (891134)		•	•	•
Cover (891137)		•	•	•
Shredder Screen Kit (891153)		•	•	•
Felt Bag (891126)		•	•	•
DUST SOCK™ Kit (840263)				
Disposable Bags (840134)				
Sand Liner (840201)				
Replacement Bag (831612)				
Parking Brake Kit (831609)				
Collapsible Hose (831018)				
Liner Sleeve (831610)				
Chariot (830257)				

\* All power levels are provided by Briggs & Stratton. \*\* All power levels are provided by Honda.





### Lightweight



### DL13 Series

DL1302HEU

An ideal combination of power and size, at 3.573 m<sup>3</sup>/h of suction, the DL13 debris loader is perfect for mid-size jobs. The unit is lightweight and equipped with a powerful Honda engine.

A dual shredding 35 cm / 14" wide armor plate impeller with Piranha™ blade reduces debris up to 12:1 and maximizes trailer loading across multiple properties before emptying, saving you time and dump fees.

The 20 cm intake hose is a 300 cm long, best in class, clear poly helical coil.

### Electric start option



### DL14 / DL18 Series

DL1402VEEU, DL1802VEU, DL1802VEEU

Step up to the midsize series of debris loaders, ideal for mid to large municipal and contractors applications. The DL14 and DL18 Series heavy-duty debris loaders are powered by Vanguard™ engines, producing suction at 6.300 m<sup>3</sup>/h. Electric start on DL1802VE reduces fatigue and saves time.

The DL18 Series debris loaders feature a 40 cm / 16" diameter armor plate steel impeller with 8 cutting points, replaceable poly liner and a 12-gauge (2,7 mm) steel housing for maximum suction power.

All debris loaders can be mounted with the optional hanger kit or skid mounted to a truck or trailer bed.

The 25 cm intake hose is a 300 cm long, clear poly helical coil.

Model shown:  
DL1802VEEU with electric start

Dual Shredding and CustomFit™ mounting options are available on all Debris Loaders.









Model shown: DL2901VEEU

### DL29 / DL37 Series

DL2901VEEU, DL3701VEEU

When commercial productivity counts, the DL29 and DL37 debris loaders are the most popular contractor and municipal machines.

The DL29 features a 29 HP V-Twin engine coupled to the largest 51 cm / 20", 4 blade, armour plated impeller with 12 cutting points and dual shredding Piranha™ technology for up to 12:1 reduction and 7.475 m<sup>3</sup>/h of suction power. For durability, the unit also features a convenient replaceable poly liner in the housing. A large 30 x 300 cm clear poly helical hose is ideal for taking huge bites out of any debris pile. The discharge chute features a no tool, no thread 360 degree unique rotational discharge chute that is hand adjustable.

The DL37's 37 HP Vanguard™ EFI engine delivers easier starting and fuel savings of up to 25% over carbureted equivalents. It is coupled to a 6-blade, armor plated impeller with 18 cutting points and dual shredding Piranha™ technology for up to 12:1 reduction and 8.580 m<sup>3</sup>/h of suction power. The 35 cm intake hose is 300 cm long.



#### Vanguard™ EFI engine

By adding closed-loop EFI, Vanguard™ engines deliver easier starting and fuel savings of up to 25%\* over carburetted equivalents. Available on DL37 Series debris loaders with 3 year warranty.



\* Closed-loop EFI system fuel savings may vary based on cutting conditions and other factors.





## Features



### Dual Shredding System with Piranha™ Blade

For extra shredding. Serrated blades with cutting points for maximum loading. Debris reduction up to 12:1.



### Safety Kill Switch

Quick connect / release hose clamp with safety interlock.



### Urethane Clear Hose

Clear hose allows for visual inspection and quick removal of hose clogs. Replacement hoses are available.

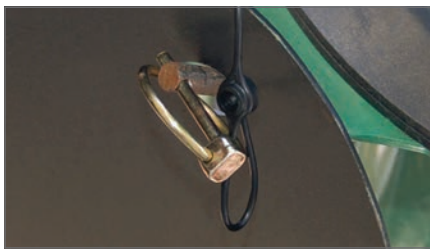

### Intake Hose Storage

Simple secure nozzle hook for convenient and efficient storage.

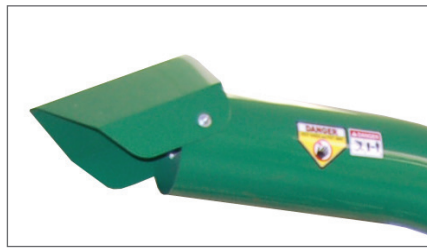

### Discharge Chute Deflector Kit

Deflects debris for most efficient loading. Also available as an accessory.



### Adjustable Rotating Discharge Chute

No tool, hand adjustable rotating discharge chute allows 360° positioning.

## CustomFit™ Mounting Options and Accessories

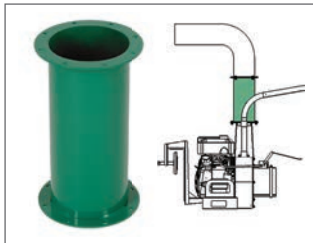

### CustomFit™ Extension Kit

Extends discharge height by 40 cm. Cannot be used with rotational kit. (792119-S)



### CustomFit™ Receiver Hitch

Simple to install and remove and easily mounts to your truck for use with DL13 and 18 loaders. (812601)



### CustomFit™ Hanger Kit

Easy to install, locks in place with 2 bolts. (812260)



### CustomFit™ Swing Away Hitch

Locks at 90° and 180° so the unit can be swung away for easy dumping. (SAH34)



### CustomFit™ Stake Body Swing Away Hitch

Simple to install. (SBSA6)

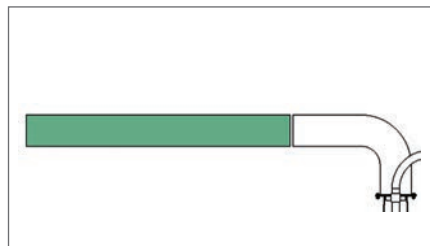

### CustomFit™ Discharge Hose Kit

Extends discharge by 150 cm on DL13 and 18 loaders for customisation to your truck or trailer. (812300)

### CustomFit™ Trailer

Includes pre-wired lights, 14" wheels, traffic cone holder & backup whip standard. Model Shown: DL2900V





## Debris Management - Debris Loaders

USE / LEVEL	MEDIUM			
	DL13 Series	DL14 Series	DL18 Series	
	DL1302HEU	DL1402VEEU	DL1802VEU	DL1802VEEU
<b>ENGINE</b>				
Engine Make	Honda	Vanguard™	Vanguard™	Vanguard™
Engine Model	GX390	400	MOD35	MOD35
Performance kW [HP]	9,7 [13,0]**	10,3 [14,0]*	13,4 [18,0]*	13,4 [18,0]*
Displacement (cc)	390	408	570	570
Engine Features	Recoil Start	Electric Start	Recoil Start	Electric Start
Fuel Capacity (l)	6.5	6.1	8.5	8.5
<b>LOADER</b>				
Productivity (m³/h)	3.575	6.300	6.300	6.300
Hose Dimensions (cm)	20 x 300	25 x 300	25 x 300	25 x 300
Impeller Blades	4	4	4	4
Impeller Diameter (inch [cm])	14.25 [36]	16 [40]	16 [40]	16 [40]
Impeller Housing	Steel 10-gauge, Replaceable Liner	Steel 12-gauge, Replaceable Liner	Steel 12-gauge, Replaceable Liner	Steel 12-gauge, Replaceable Liner
Cutting Points	8	8	8	8
Output Diameter (cm)	18	18	18	18
<b>DIMENSIONS / WEIGHT</b>				
Weight (kg)	93.9	121.1	121.1	121.1
Length (cm)	120	152	152	152
Width (cm)	69	82	82	82
Height (cm)	79	190	190	190
<b>ACCESSORIES</b>				
CustomFit™ Extension Kit (812123)	•	•	•	•
CustomFit™ Extension Kit (792119-S)				
CustomFit™ Hanger Kit (812260)	•	•	•	•
CustomFit™ Trailer (on request only)	•	•	•	•
CustomFit™ Swing Away Hitch (SAH34)	•	•	•	•
CustomFit™ Receiver Hitch (812601)	•	•	•	•
CustomFit™ Stake Body Swing Away Hitch (SBSA6)	•	•	•	•
CustomFit™ Discharge Urethane Hose Kit (812300)	•	•	•	•
CustomFit™ Discharge Metal Hose Kit (791106)				
Replacement Hose (811244)	•			
Replacement Hose (791033)		•	•	•
360 Rotational Kit (812332)	•	•	•	•
8" Hose Coupler (811244)	•			
Optional Discharge Chute Deflector Kit (812295)				



\* All power levels are provided by Briggs & Stratton. \*\* All power levels are provided by Honda.





**LARGE**

<b>DL29 Series</b>	<b>DL37 Series</b>
DL2901VEEU	DL3701VEEU

Vanguard™	Vanguard™
MOD54	MOD61 EFI
21,6 [29,0]¹	27,6 [37,0]¹
896	993
Electric Start	Electric Start, Electronic Fuel Injection
22	22

7.475	8.580
30 x 200	35 x 250
4	6
20 [51]	20 [51]
Steel 12-gauge, Replaceable Liner	Steel 12-gauge, Replaceable Liner
12	18
20	20

215	215
152	152
82	82
190	190

•	•
•	•
•	•
•	•
•	•
•	•
•	•
•	•



Your Billy Goat Distributor:

Your Billy Goat Dealer:



**Billy Goat EMEA**

BRIGGS & STRATTON NETHERLANDS BV  
SCHEPERSWEG 4C, 6049 CV ROERMOND  
THE NETHERLANDS

Tel: +31 (0)475 408 383  
Fax: +31 (0)475 408 384

**[WWW.BILLYGOAT.COM](http://WWW.BILLYGOAT.COM)**